

ISO 9001 by L.R.
PED DIR. 2014/68/UE by L.R.
ATEX DIR. 2014/34/UE by B.V.
FIRE SAFE EXECUTION by L.R.
ISO 15848 by TÜV
ANTISTATIC DEVICE by L.R.
FIRE SAFE TESTED ISO 10497 by L.R.
EAC CERTIFICATION by B.V.

TYPE
FB1
PN 10 ÷ 40
ANSI 150

NORME E DIRETTIVE APPLICATE DISPONIBILI AL SEGUENTE LINK:
STANDARD AND DIRECTIVE APPLIED AVAILABLE AT FOLLOWING LINK:
http://www.adlerspa.com/pdf/NORME_ADLER.pdf

VALVOLE A SFERA "CORPO PIATTO" PASSAGGIO TOTALE

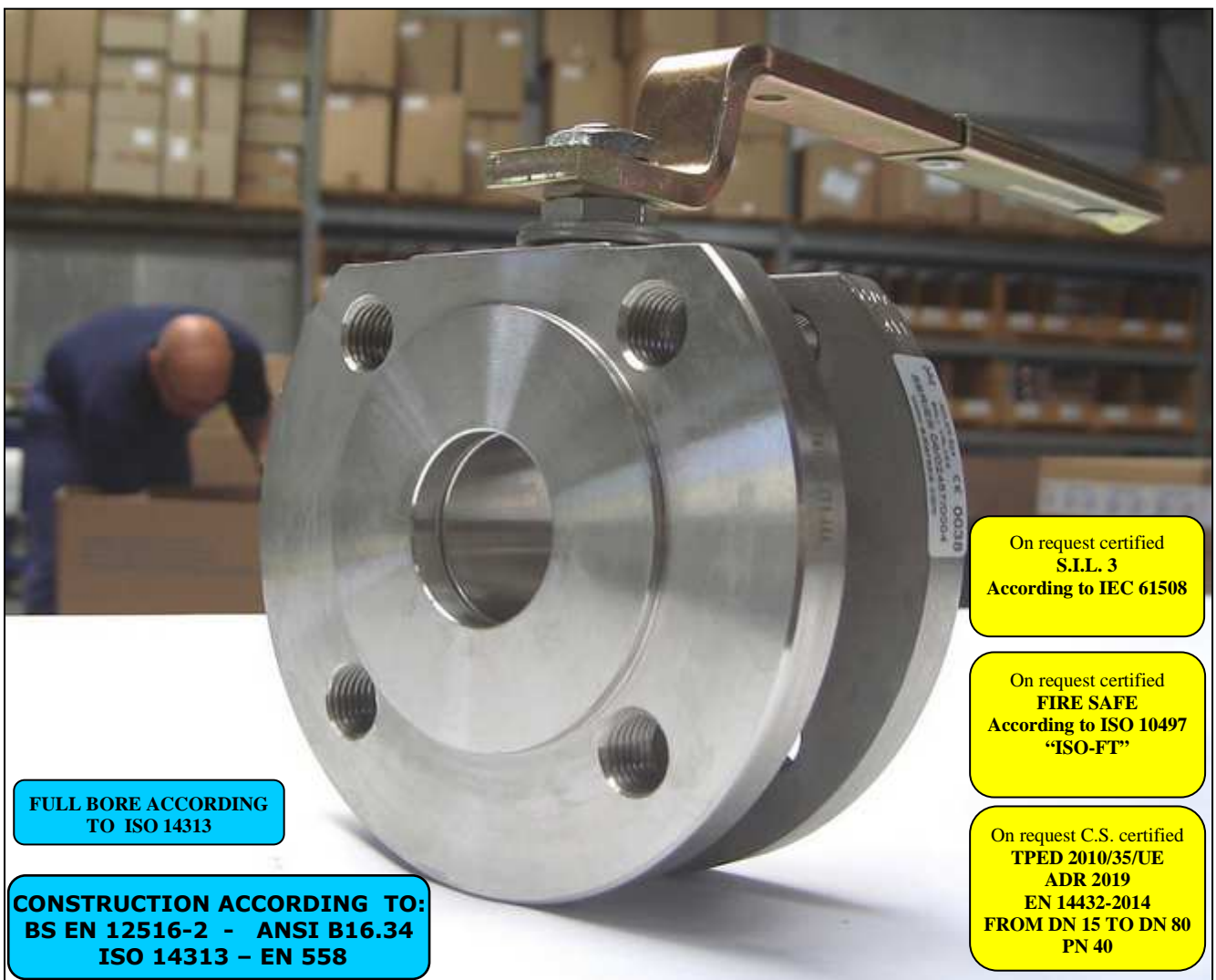

FULL BORE ACCORDING
TO ISO 14313

CONSTRUCTION ACCORDING TO:
BS EN 12516-2 - ANSI B16.34
ISO 14313 - EN 558

On request certified
S.I.L. 3
According to IEC 61508

On request certified
FIRE SAFE
According to ISO 10497
"ISO-FT"

On request C.S. certified
TPED 2010/35/UE
ADR 2019
EN 14432-2014
FROM DN 15 TO DN 80
PN 40

BALL VALVES "WAFER TYPE" FULL BORE
ROBINETS A BOISSEAU SPHERIQUE
"WAFER" PASSAGE INTEGRAL
FLANSCHKUGELHÄHNE IN "KOMPAKTBAUWEISE"
VOLLER DURCHGANG

WEB SITE: WWW.ADLERSPA.COM

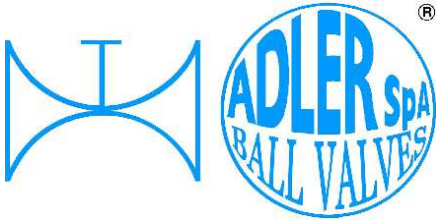

ISO 9001 by L.R.
 PED DIR. 2014/68/UE by L.R.
 ATEX DIR. 2014/34/UE by B.V.
 FIRE SAFE EXECUTION by L.R.
 ISO 15848 by TÜV
 ANTISTATIC DEVICE by L.R.
 FIRE SAFE TESTED ISO 10497 by L.R.
 EAC CERTIFICATION by B.V.

TYPE
FB1
 PN 10 ÷ 40
 ANSI 150

VALVOLA A SFERA "CORPO PIATTO" PASSAGGIO TOTALE
BALL VALVES "WAFER TYPE" FULL BORE
ROBINETS A BOISSEAU SPHERIQUE "WAFER" PASSAGE INTEGRAL
FLANSCHKUGELHÄHNE IN "KOMPAKTBAUWEISE" VOLLER DURCHGANG

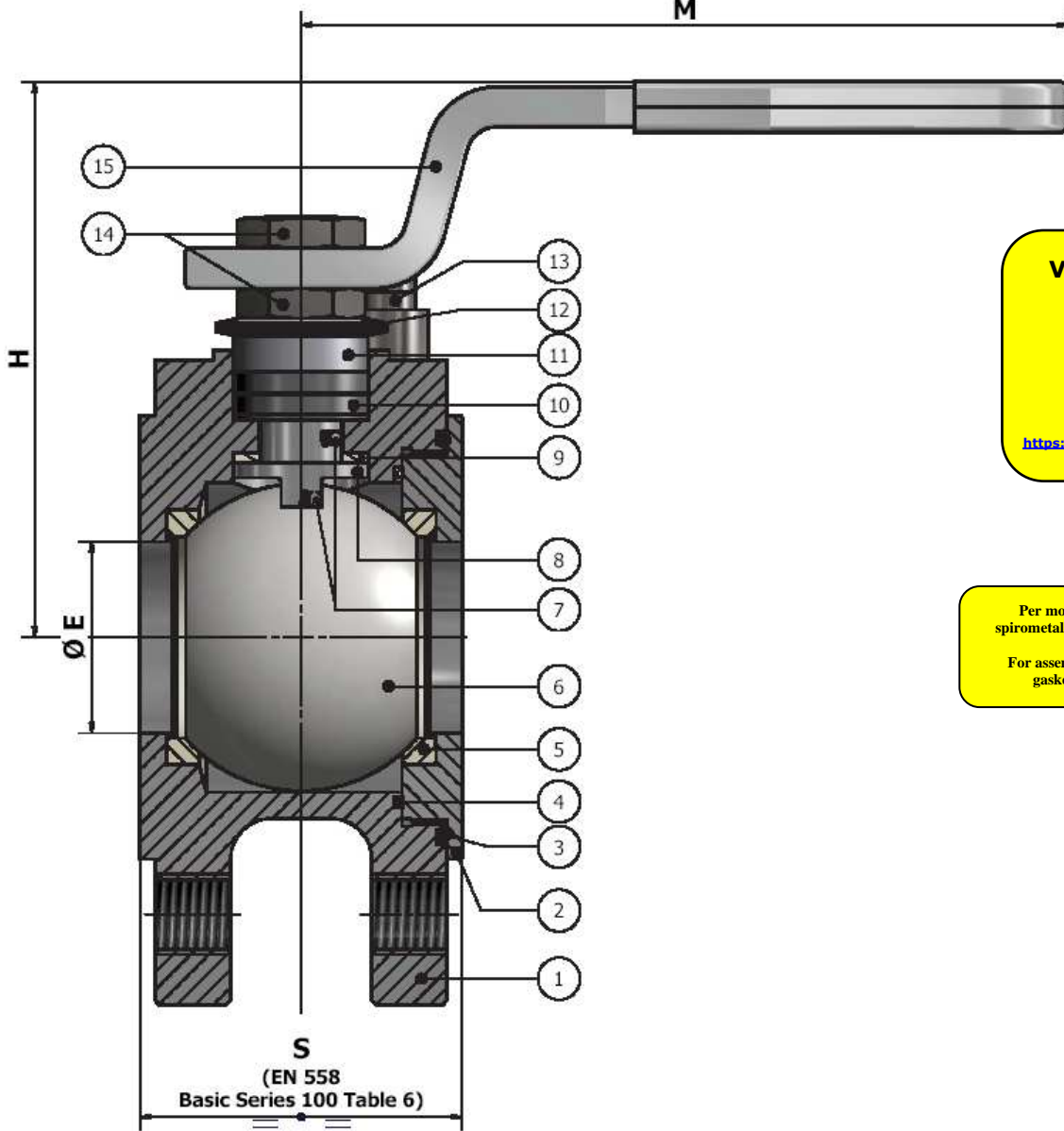

**VISUALIZZA 3D
 VIEW 3D**

<https://adlerspa.com/prodotti/fb1>

Per montaggio con guarnizioni
 spirali metalliche, contattare Adler Spa.
 For assembling with spiral-wound
 gaskets, contact Adler Spa

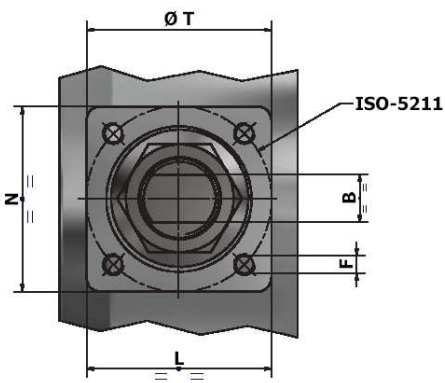
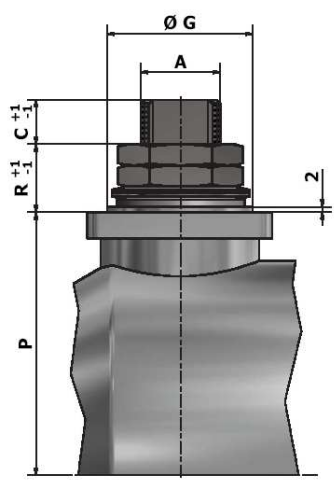

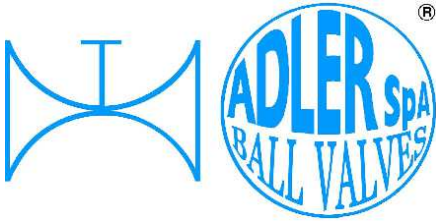

ISO 9001 by L.R.
 PED DIR. 2014/68/UE by L.R.
 ATEX DIR. 2014/34/UE by B.V.
 FIRE SAFE EXECUTION by L.R.
 ISO 15848 by TÜV
 ANTISTATIC DEVICE by L.R.
 FIRE SAFE TESTED ISO 10497 by L.R.
 EAC CERTIFICATION by B.V.

TYPE
FB1
 PN 10 ÷ 40
 ANSI 150

N.	DESCRIZIONE DESCRIPTION DESCRIPTION BESCHREIBUNG	MATERIALI MATERIALS MATERIAUX WERKSTOFFE
1	CORPO BODY CORPS MITTE	ASTM A 351 CF8 ASTM A 351 CF8M
2	GHIERA INSERT EMBOUT GEWINDED RUCKRING	ASTM A479 304/304L ASTM A479 316/316L
3*	O-RING	FKM - (VITON)
4*	ANELLO SEAL ANNEAU DICHTUNGSRING	P.T.F.E.
5*	SEDE SEAT SIEGE SITZRING	P.T.F.E. R.P.T.F.E. (OPTIONAL)
6	SFERA BALL BOULE KUGEL	ASTM A479 304/304L ASTM A351 CF8 ASTM A479 316/316L ASTM A351 CF8M
7	DISPOSITIVO ANTISTATICO ANTISTATIC DEVICE CONTACT ANTISTATIQUE ANTISTATIK VORRICHTUNG	ASTM A479 316/316L
8	STELO STEM TIGE SPINDEL	ASTM A479 304/304L ASTM A479 316/316L

N.	DESCRIZIONE DESCRIPTION DESCRIPTION BESCHREIBUNG	MATERIALI MATERIALS MATERIAUX WERKSTOFFE
9*	BUSSOLA STEM SEAL JOINT TIGE UNTERE SPINDELABDICHTUNG	P.T.F.E.
10*	PACCO A "V" CHEVRON RINGS JOINT A "V" 3 FACHE DACHMANSCHETTE	P.T.F.E. / GRAFITE P.T.F.E. / GRAPHITE P.T.F.E. / GRAPHITE P.T.F.E. / GRAPHIT
11	PREMIBUSSOLA PRESSING BUSH PRESSE RONDELLE STOPFBUCHSDRUCKRING	ASTM A479 304
12	MOLLE A TAZZA SPRING WASHERS RONDELLES BELLEVILLE TELLERFEDERN	C72/50Cr V4 ZINCATO - GALVANIZED - ZINGUE - VERZINKT X10CrNi18.8 ON REQUEST
13	VITE DI FERMO E FERMO PIN AND STOP PIN PLONT ET PLOT D'ARRET ANSCHLAGBOLZEN	UNI3740 8.8 ZINCATO - GALVANIZED - ZINGUE - VERZINKT UNI 3951 A2-70 ON REQUEST
14	DADO - CONTRODADO NUT - LOCK NUT ECROU - CONTRE-ECROU MUTTER - KONTERMUTTER	AISI 1010 ZINCATO - GALVANIZED - ZINGUE - VERZINKT ASTM A479 304 ON REQUEST
15	LEVA WRENCH LEVIER HANDHEBEL	AISI 1010 CHROMED FOR S.S. VALVES PAINTED FOR C.S. VALVES ASTM A479 304 ON REQUEST
16		

* RICAMBI CONSIGLIATI - RECOMMENDED SPARE PARTS - PIECES DE RECHANGE CONSEILLEES - ERSATZTEIL EMPFEHLUNG

ON REQUEST P.T.F.E. AVAILABLE CERTIFIED BAM, FDA, MOCA

DIMENSIONI - DIMENSION - DIMENSIONS - ABMESSUNGEN

DN	15	20	25	32	40	50	65	80	100	125	150	200	250	300
A					16	16	22	22	30	30				
B					10	10	14	14	18	18				
C					10	10	12	12	17	17				
E					38	51	64	76	101	118				
F					M6	M6	M8	M8	M8	M10				
ISO					F05	F05	F07	F07	F07	F10				
G					35	35	55	55	55	70				
H					110	120	144	152	174	188				
L					58	56	67	68	70	97				
M					280	280	370	370	470	650				
N					54	54	70	70	70	97				
P					55	65	82	90,5	99,5	113				
R					20	21	24	24	27	27				
S					64	84	103	120	154	182				
T					50	50	70	70	70	102				
~Kg					5	7	11	15	20	31				

TYPE
FA1
 VEDERE
 SEE
 VOIR
 SIEHE
 DN 15 ÷ 40
 PN 10 ÷ 40
 ANSI 150 ÷ 300

TYPE
FB2
 VEDERE
 SEE
 VOIR
 SIEHE
 DN 150 ÷ 250
 PN 10 ÷ 40
 ANSI 150 ÷ 300

OPTIONAL TYPE
FA2
 VEDERE
 SEE
 VOIR
 SIEHE
 DN 15 ÷ 250
 PN 10 ÷ 40
 ANSI 150 ÷ 300

- DATI E CARATTERISTICHE SOGGETTI A VARIAZIONI SENZA PREAVVISO
- SPECIFICATIONS SUBJECT TO MODIFICATIONS WITHOUT PRIOR NOTICE
- TOUS DROITS DE MODIFICATION RESERVES
- KONSTRUKTIONÄNDERUNGEN VORBEHALTEN



ADLER SpA - BALL VALVES
 20010 S. STEFANO TICINO (MI) ITALY V.le BORLETTI, 14 Tel. +39/02974842.11 FAX +39/0297271698
 E-mail: adler@adlerspa.com <http://www.adlerspa.com>

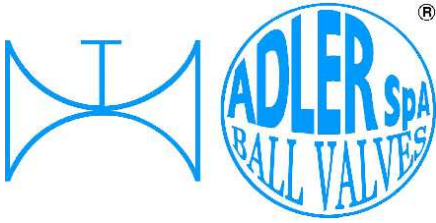

ISO 9001 by L.R.
 PED DIR. 2014/68/UE by L.R.
 ATEX DIR. 2014/34/UE by B.V.
 FIRE SAFE EXECUTION by L.R.
 ISO 15848 by TÜV
 ANTISTATIC DEVICE by L.R.
 FIRE SAFE TESTED ISO 10497 by L.R.
 EAC CERTIFICATION by B.V.

TYPE
FB1
 PN 10 ÷ 40
 ANSI 150

· ESECUZIONI · EXECUTIONS · EXECUTIONS · AUSFÜHRUNGEN



EXECUTION 4-12

ONLY FOR VALVES \geq DN 50 **S**

FORO DI BILANCIAMENTO
 BALANCING HOLE
 TROU DE BALANCEMENT
 DRUCKENTLASTUNGSBOHRUNG

ON REQUEST AVAILABLE ON DN \leq 40



EXECUTION 6-16

S STANDARD

O OPTIONAL

1 **S**

-MONTAGGIO VITI – SCREW ASSEMBLING
 -MONTAGE VIS – EINBAU MIT SCHRAUBEN

2 **O**

-MONTAGGIO DI FONDO
 -END TANK ASSEMBLING
 -MONTAGE FOND DE CUVE
 -EINBAU ALS BODENABBLASSKUGELHAHN

3 **O**

-MONTAGGIO BULLONI
 -BOLTS ASSEMBLING
 -MONTAGE BOULONS
 EINBAU MIT ZUGBOLZEN

4 **S**

-STELO ANTI ESPULSIONE – ANTI BLOW OUT STEM
 -TIGE ANTIEXPULSION – AUSBLASGESICHERETE WELLE

-PACCO A "V" – CHEVRON RINGS
 -JOINT A "V" – 3 FACHE DACHMANSCHETE
 ANTISTATIC DEVICE ANTISTATIK VORRICHTUNG
 BS 5146

ISO 15848 -1 CERTIFICATION

6 **O**

BREVETTO – PATENTED
 00219688 - 21-04-1993
 FKM (VITON)

-“O” RING STELO “O” RING ON STEM
 -TIGE AVEC “O” RING
 -“O” RING IM SPINDELBEREICH

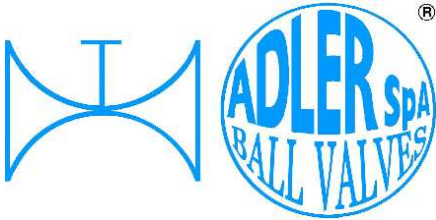

ISO 9001 by L.R.
 PED DIR. 2014/68/UE by L.R.
 ATEX DIR. 2014/34/UE by B.V.
 FIRE SAFE EXECUTION by L.R.
 ISO 15848 by TÜV
 ANTISTATIC DEVICE by L.R.
 FIRE SAFE TESTED ISO 10497 by L.R.
 EAC CERTIFICATION by B.V.

TYPE
FB1
 PN 10 ÷ 40
 ANSI 150

7

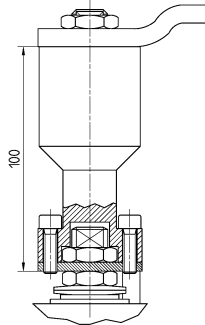

-PROLUNGA STELO -STEM EXTENSION
 -TIGE PROLONGEE -SPINDELVERLÄNGERUNG

8

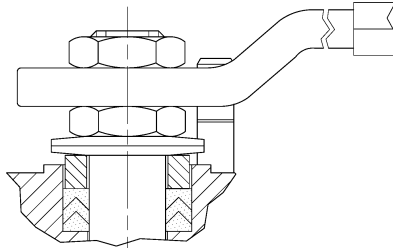

-PARTICOLARI INOX
 -STAINLESS STEEL DETAILS
 -ACCESSOIRES EN INOX
 -EDELSTAHLTEILE

9

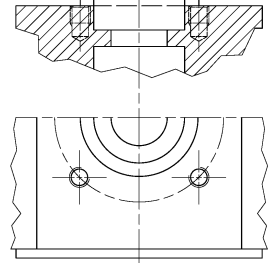

-ATTACCO "ISO" -"ISO" CONNECTIONS
 -SYSTEM "ISO" -ANSCHLUSS "ISO"

10

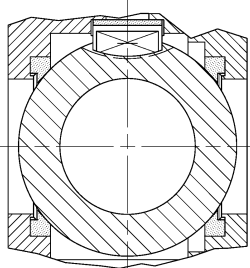

-SFERA CONTENUTA -CONTENTS BALL
 -BOULE CONTENUE
 -NICHT RAUSRAGENDE KUGEL

11

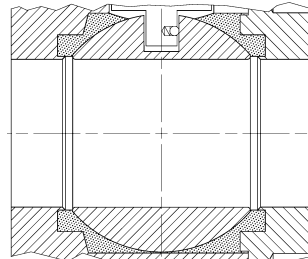

-TENUTE INTEGRALE -POCKETLESS SEATS
 -TENUE INTEGRALE -TOTRAUMARM
 -P.T.F.E. / R.T.F.E.

12

FIRE SAFE
 ISO 10497 "ISO-FT"
 (BS 6755 / API 607)



13

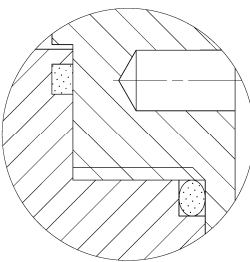

-DOPPIA TENUTA -DOUBLE SEALS
 -DOUBLE ETANCHEITE -DOPPELTE ABDICHTUNG
 -GHIERA A BATTUTA -METAL BEATING RING
 -EMBOUT AVEC BATTUE MECANIQUE
 -METALLISCHER ANSCHLAG DES
 GEWINDEDRUCKRINGS

14

VEDERE / SEE ANSI B16.34

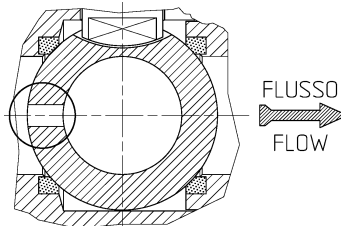

-FORO DI SCARICO NELLA SFERA
 -OVERPRESSURE HOLE INTO BALL
 -TROU DECOMPRESSION DANS LA BOULE
 -ENTLASTUNGSBOHRUNG IN DER KUGEL
 VALVOLA MONO DIREZIONALE
 MONO-DIRECTIONAL VALVE

15

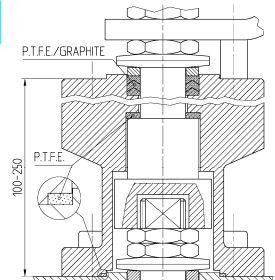

-SERVIZIO CRIOGENICO -CRYOGENIC SERVICE
 -SERVICE CRYOGENIQUE
 -TIEFTEMPORATUR SERVICE

16



-FIRE SAFE ISO FT+ "O" RING STELO
 -FIRE SAFE ISO FT+ "O" RING ON STEM
 -SECURITE FEU ISO FT+ TIGE AVEC "O" RING
 -FEUERSICHERE AUSFÜHRUNG ISO FT +
 "O" RING IM SPINDELBEREICH

ADLER

UNA GAMMA COMPLETA
 PRIVILEGIANDO LA QUALITA'
 A COMPLETE RANGE PRIVILEGING
 THE QUALITY

18

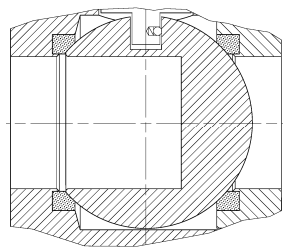

-SFERA CIECA PER CAMPIONATURA
 -BLIND BALL FOR SAMPLING
 -PRISE-ECHANTILLON
 KUGEL FÜR PROBENAHME

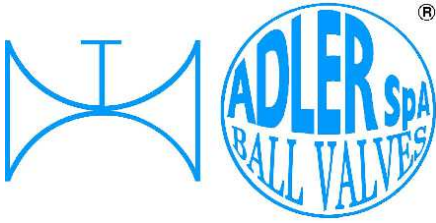

ISO 9001 by L.R.
 PED DIR. 2014/68/UE by L.R.
 ATEX DIR. 2014/34/UE by B.V.
 FIRE SAFE EXECUTION by L.R.
 ISO 15848 by TÜV
 ANTISTATIC DEVICE by L.R.
 FIRE SAFE TESTED ISO 10497 by L.R.
 EAC CERTIFICATION by B.V.

TYPE
FB1
 PN 10 ÷ 40
 ANSI 150

VITI D'ASSEMBLAGGIO PER FB1 - ASSEMBLING SCREWS FOR FB1 - VIS D'ASSEMBLAGE POUR FB1- MONTAGESCHRAUBEN FÜR FB1

N° VITI - DIMENSIONE • N° SCREW - DIMENSIONS • N° VIS- DIMENSIONS • N° SCHRAUBEN-ABMESSUNGEN

EUROPEAN NORM

DN PN	10-15	20	25	32	40	50	65	80	100	125	150
10					8 M16 X35	8 M16 X40	8 M16 X40	* 16 M16 X40	16 M16 X40	16 M16 X45	
16					8 M16 X35	8 M16 X40	8 M16 X40	16 M16 X40	16 M16 X40	16 M16 X45	
25					8 M16 X40	8 M16 X40	16 M16 X45	16 M16 X45	16 M20 X50	16 M24 X55	
40					8 M16 X40	8 M16 X40	16 M16 X45	16 M16 X45	16 M20 X50	16 M24 X55	

ANSI METRIC

(STANDARD ADLER)

Ø Rating	1/2"	3/4"	1"	1 1/4"	1 1/2"	2"	2 1/2"	3"	4"	5"	6"
150					8 M14 X35	8 M16 X40	8 M16 X40	8 M16 X45	16 M16 X45	16 M20 X50	

ANSI B1.1 UNC

(ON REQUEST)

Ø Rating	1/2"	3/4"	1"	1 1/4"	1 1/2"	2"	2 1/2"	3"	4"	5"	6"
150					8 1/2 X 1 1/2	8 5/8 X 1 1/2	8 5/8 X 1 3/4	8 5/8 X 1 3/4	16 5/8 X 1 3/4	16 3/4 X 2	

Length of screws calculated considering a gasket with thickness of 2mm.

