

ISO 9001 by L.R.
PED DIR. 2014/68/UE by L.R.
ATEX DIR. 2014/34/UE by B.V.
FIRE SAFE EXECUTION by L.R.
ISO 15848 by TÜV
ANTISTATIC DEVICE by L.R.
FIRE SAFE TESTED ISO 10497 by L.R.
EAC CERTIFICATION by B.V.

TYPE
FC1
PN 63 ÷ 100 ÷ 160
ANSI 600 ÷ 900 ÷ 1500

NORME E DIRETTIVE APPLICATE DISPONIBILI AL SEGUENTE LINK:
STANDARD AND DIRECTIVE APPLIED AVAILABLE AT FOLLOWING LINK:
http://www.adlerspa.com/pdf/NORME_ADLER.pdf

VALVOLE A SFERA "CORPO PIATTO" PASSAGGIO TOTALE

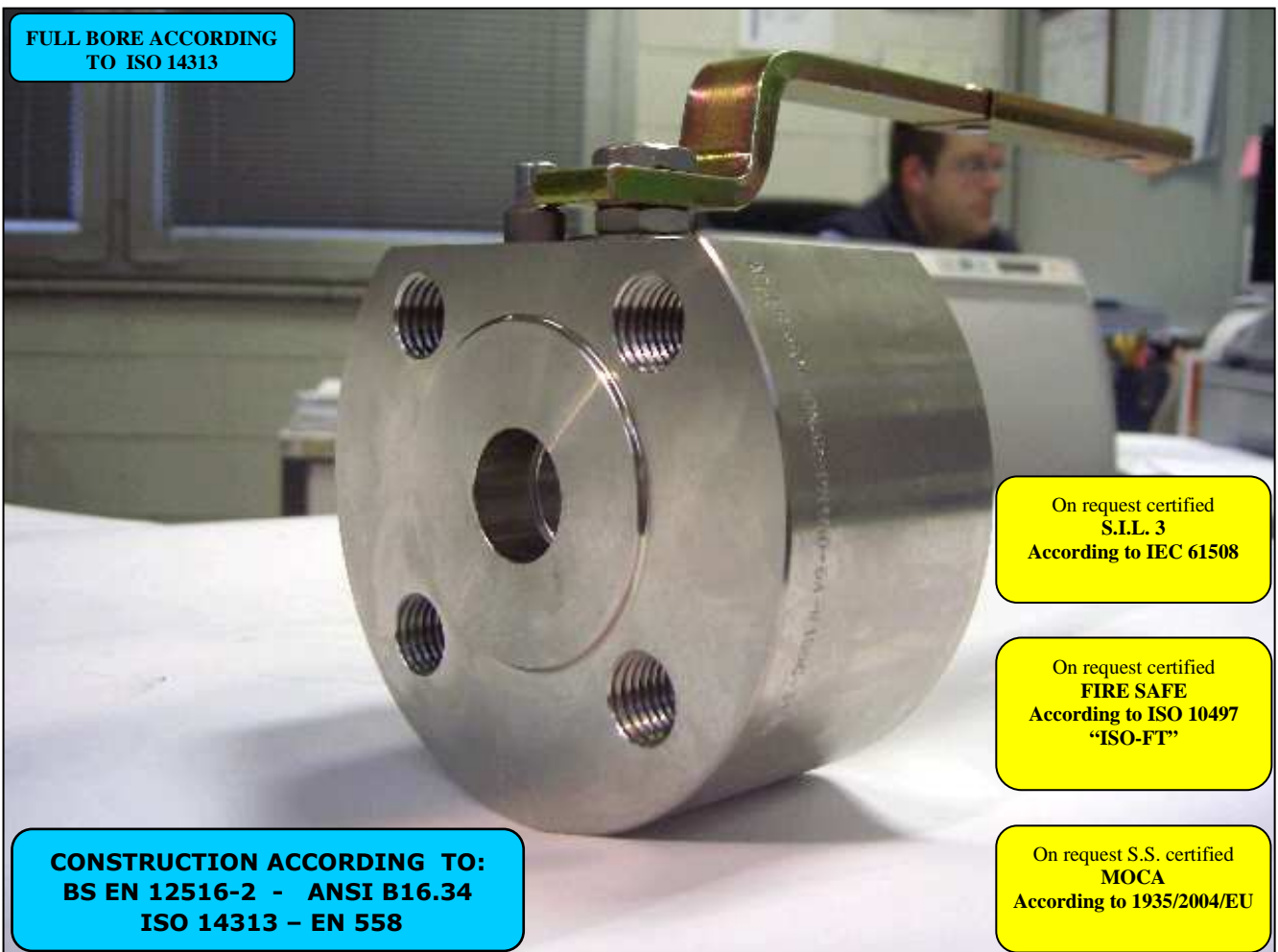

**BALL VALVES "WAFER TYPE" FULL BORE
ROBINETS A BOISSEAU SPHERIQUE
"WAFER" PASSAGE INTEGRAL
FLANSCHKUGELHÄHNE IN "KOMPAKTBAUWEISE"
VOLLER DURCHGANG**

WEB SITE: WWW.ADLERSPA.COM

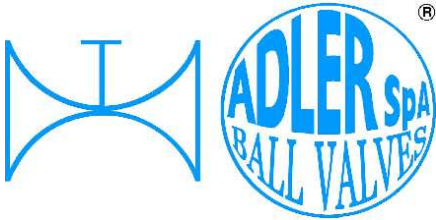

ISO 9001 by L.R.
 PED DIR. 2014/68/UE by L.R.
 ATEX DIR. 2014/34/UE by B.V.
 FIRE SAFE EXECUTION by L.R.
 ISO 15848 by TÜV
 ANTISTATIC DEVICE by L.R.
 FIRE SAFE TESTED ISO 10497 by L.R.
 EAC CERTIFICATION by B.V.

TYPE
FC1
 PN 63 ÷ 100 ÷ 160
 ANSI 600 ÷ 900 ÷ 1500

VALVOLA A SFERA "CORPO PIATTO" PASSAGGIO TOTALE
BALL VALVES "WAFFER TYPE" FULL BORE
ROBINETS A BOISSEAU SPHERIQUE "WAFER" PASSAGE INTEGRAL
FLANSCHKUGELHÄHNE IN "KOMPAKTBAUWEISE" VOLLER DURCHGANG

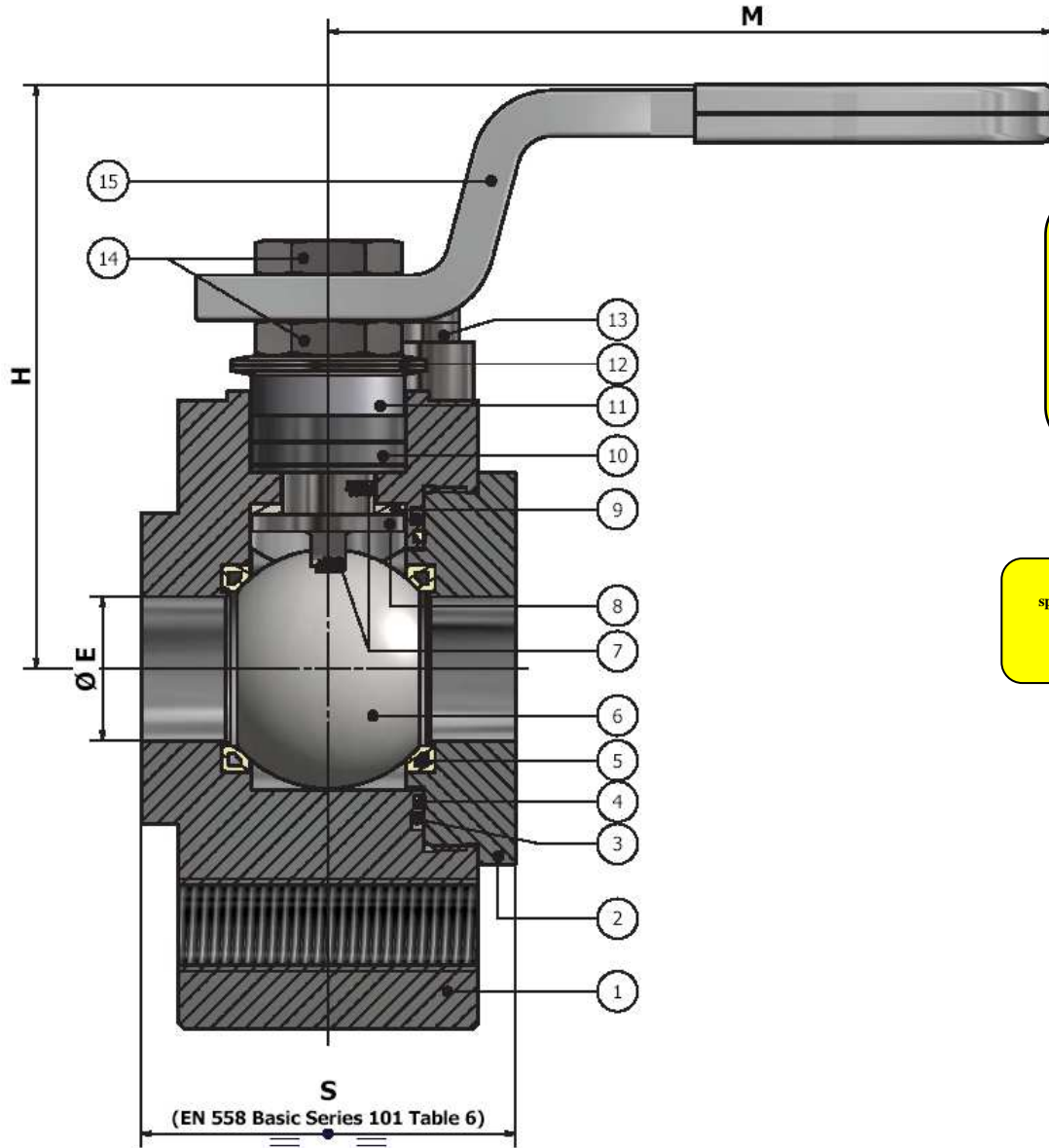

**VISUALIZZA 3D
 VIEW 3D**

<https://adlerspa.com/prodotti/fc1>

Per montaggio con guarnizioni
 spirometalliche, contattare Adler Spa.
 For assembling with spiral-wound
 gaskets, contact Adler Spa

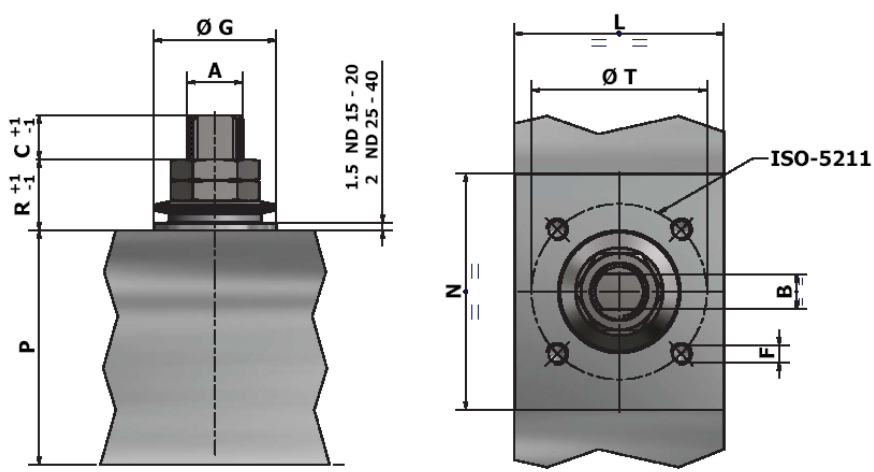

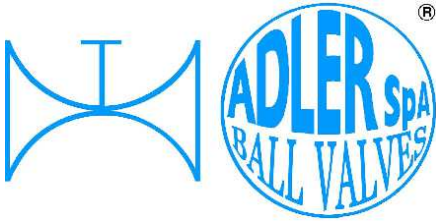

ISO 9001 by L.R.
 PED DIR. 2014/68/UE by L.R.
 ATEX DIR. 2014/34/UE by B.V.
 FIRE SAFE EXECUTION by L.R.
 ISO 15848 by TÜV
 ANTISTATIC DEVICE by L.R.
 FIRE SAFE TESTED ISO 10497 by L.R.
 EAC CERTIFICATION by B.V.

TYPE
FC1
 PN 63 ÷ 100 ÷ 160
 ANSI 600 ÷ 900 ÷ 1500

N.	DESCRIZIONE DESCRIPTION DESCRIPTION BESCHREIBUNG	MATERIALI MATERIALS MATERIAUX WERKSTOFFE
1	CORPO BODY CORPS MITTE	ASTM A105 ASTM A479 304/304L ASTM A479 316/316L
2	GHIERA INSERT EMBOUT GEWINDED RUCKRING	ASTM A105 ASTM A479 304/304L ASTM A479 316/316L
3*	O-RING	FKM - (VITON)
4*	ANELLO SEAL ANNEAU DICHTUNGSRING	P.T.F.E.
5*	SEDE RINFORZATA SEAT REINFORCED SIEGE RENFORCEE SITZRING VERSTÄRKT	P.T.F.E. / STAINLESS STEEL
6	SFERA BALL BOULE KUGEL	ASTM A479 304/304L ASTM A351 CF8 ASTM A479 316/316L ASTM A351 CF8M
7	DISPOSITIVO ANTISTATICO ANTISTATIC DEVICE CONTACT ANTISTATIQUE ANTISTATIK VORRICHTUNG	ASTM A479 316/316L
8	STELO STEM TIGE SPINDEL	ASTM A479 304/304L ASTM A479 316/316L

N.	DESCRIZIONE DESCRIPTION DESCRIPTION BESCHREIBUNG	MATERIALI MATERIALS MATERIAUX WERKSTOFFE
9*	BUSSOLA STEM SEAL JOINT TIGE UNTERE SPINDELABDICHTUNG	P.T.F.E.
10*	PACCO A "V" CHEVRON RINGS JOINT A "V" 3 FACHE DACHMANSCHETTE	P.T.F.E. / GRAFITE P.T.F.E. / GRAPHITE P.T.F.E. / GRAPHITE P.T.F.E. / GRAPHIT
11	PREMIBUSSOLA PRESSING BUSH PRESSE RONDELLE STOPFBUCHSDRUCKRING	ASTM A479 304
12	MOLLE A TAZZA SPRING WASHERS RONDELLES BELLEVILLE TELLERFEDERN	C72/50Cr V ₄ ZINCATO - GALVANIZED ZINGUE - VERZINKT X10CrNi18.8 ON REQUEST
13	VITE DI FERMO E FERMO PIN AND STOP PIN PLOT ET PLOT D'ARRET ANSCHLAGBOLZEN	UNI 3951 A2-70 ZINCATO - GALVANIZED - ZINGUE - VERZINKT UNI 3740 - 6S ON REQUEST
14	DADO - CONTRODADO NUT - LOCK NUT ECROU - CONTRE-ECROU MUTTER - KONTERMUTTER	UNI 3740 - 6S ZINCATO - GALVANIZED ZINGUE - VERZINKT ASTM A479 304 ON REQUEST
15	LEVA WRENCH LEVIER HANDHEBEL	AISI 1010 CHROMED FOR S.S. VALVES ASTM A479 304 PAINTED FOR C.S. VALVES ON REQUEST
16		

* RICAMBI CONSIGLIATI - RECOMMENDED SPARE PARTS - PIECES DE RECHANGE CONSEILLEES - ERSATZTEIL EMPFEHLUNG

ON REQUEST P.T.F.E. AVAILABLE CERTIFIED BAM, FDA, MOCA

DIMENSIONI - DIMENSION - DIMENSIONS - ABMESSUNGEN

DN	10	15	20	25	32	40	50	65	80	100	125	150	200	250	300
A		12	12	16	16	22									
B		8	8	10	10	14									
C		10	10	10	10	12									
E		15	19	25	30	38									
F		M5	M5	M6	M6	M8									
ISO		F03	F03	F05	F05	F07									
G		25	25	35	35	55									
H		78	80	101	104	129									
L		51	56	61	71	79									
M		185	185	280	280	370									
N		76	97	97	107	104									
P		36	43	50	56	67									
R		14	9	16	14	24									
P		36	43	46	50	67									
R		14	8	20	20	24									
S		55	60	65	75	85									
T		36	36	50	50	70									
~Kg		2,2	3,7	4,5	6,3	9,5									

TYPE
FC2
 VEDERE
 SEE
 VOIR
 SIEHE
 PN 63-100-160
 ANSI 600

- DATI E CARATTERISTICHE SOGGETTI A VARIAZIONI SENZA PREAVVISO
- SPECIFICATIONS SUBJECT TO MODIFICATIONS WITHOUT PRIOR NOTICE
- TOUS DROITS DE MODIFICATION RESERVES
- KONSTRUKTIONÄNDERUNGEN VORBEHALTEN

PN 63 ÷ 100 ÷ 160

ANSI 600



ADLER SpA - BALL VALVES
 20010 S. STEFANO TICINO (MI) ITALY V.le BORLETTI, 14 Tel. +39/02974842.11 FAX +39/0297271698
 E-mail: adler@adlerspa.com <http://www.adlerspa.com>

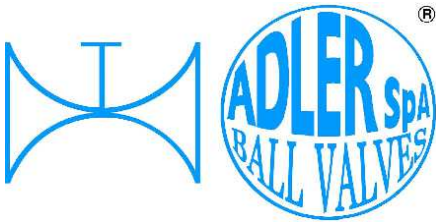

ISO 9001 by L.R.
 PED DIR. 2014/68/UE by L.R.
 ATEX DIR. 2014/34/UE by B.V.
 FIRE SAFE EXECUTION by L.R.
 ISO 15848 by TÜV
 ANTISTATIC DEVICE by L.R.
 FIRE SAFE TESTED ISO 10497 by L.R.
 EAC CERTIFICATION by B.V.

TYPE
FC1
 PN 63 ÷ 100 ÷ 160
 ANSI 600 ÷ 900 ÷ 1500

• ESECUZIONI • EXECUTIONS • EXECUTIONS • AUSFÜHRUNGEN



EXECUTION 4- 12

ONLY FOR VALVES \geq DN 50 **S**

FORO DI BILANCIAMENTO
 BALANCING HOLE
 TROU DE BALANCEMENT
 DRUCKENTLASTUNGSBOHRUNG

ON REQUEST AVAILABLE ON DN \leq 40



EXECUTION 6 - 16

S STANDARD

O OPTIONAL

1 **S**

-MONTAGGIO VITI – SCREW ASSEMBLING
 -MONTAGE VIS – EINBAU MIT SCHRAUBEN



ADLER

UNA GAMMA COMPLETA
 PRIVILEGIANDO LA QUALITA'

A COMPLETE RANGE PRIVILEGING
 THE QUALITY

4 **S**

-STELO ANTI ESPULSIONE -ANTI BLOW OUT STEM
 -TIGE ANTIEXPULSION -AUSBLASGESICHERETE WELLE

-PACCO A "V" -CHEVRON RINGS
 -JOINT A "V" -3 FACHE DACHMANSCHETE
 ANTISTATIC DEVICE ANTISTATIK VORRICHTUNG
 BS 5146

ISO 15848 CERTIFICATION

6 **O**

BREVETTO - PATENTED
 00219688 - 21-04-1993

FKM (VITON)

-“O” RING STELO “O” RING ON STEM
 -TIGE AVEC “O” RING
 -“O” RING IM SPINDELBEREICH

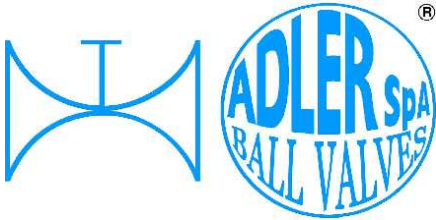

ISO 9001 by L.R.
 PED DIR. 2014/68/UE by L.R.
 ATEX DIR. 2014/34/UE by B.V.
 FIRE SAFE EXECUTION by L.R.
 ISO 15848 by TÜV
 ANTISTATIC DEVICE by L.R.
 FIRE SAFE TESTED ISO 10497 by L.R.
 EAC CERTIFICATION by B.V.

TYPE
FC1
 PN 63 ÷ 100 ÷ 160
 ANSI 600÷900÷1500

7

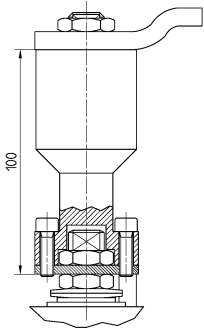

-PROLUNGA STELO -STEM EXTENSION
 -TIGE PROLONGEE -SPINDELVERLÄNGERUNG

8

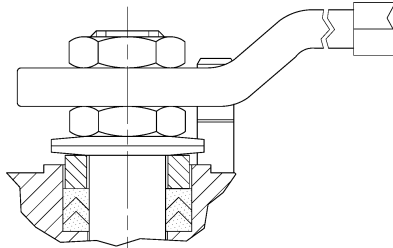

-PARTICOLARI INOX
 -STAINLESS STEEL DETAILS
 -ACCESSOIRES EN INOX
 -EDELSTAHLTEILE

9

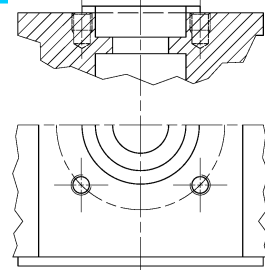

-ATTACCO "ISO" -"ISO" CONNECTIONS
 -SYSTEM "ISO" -ANSCHLUSS "ISO"

10

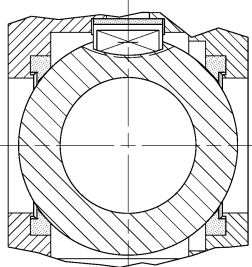

-SFERA CONTENUTA -CONTENTS BALL
 -BOULE CONTENUE
 -NICHT RAUSRAGENDE KUGEL

LOCKING DEVICE
 OPEN OR CLOSE POSITIONS



12

FIRE SAFE
 ISO 10497 "ISO-FT"
 (BS 6755 / API 607)



13

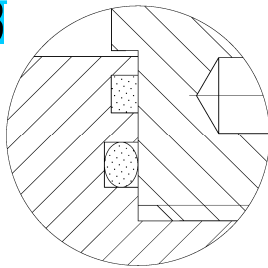

-DOPPIA TENUTA -DOUBLE SEALS
 -DOUBLE ETANCHEITE -DOPPELTE ABDICHTUNG
 -GHIERA A BATTUTA -METAL BEATING RING
 -EMBOUT AVEC BATTUE MECANIQUE
 -METALLISCHER ANSCHLAG DES
 GEWINDEDRUCKRINGS

14

VEDERE / SEE ANSI B16.34

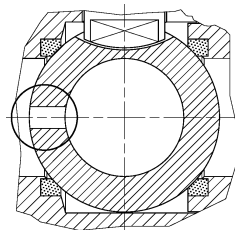

FLUSSO
 FLOW

-FORO DI SCARICO NELLA SFERA
 -OVERPRESSURE HOLE INTO BALL
 -TROU DECOMPRESSION DANS LA BOULE
 -ENTLASTUNGSBOHRUNG IN DER KUGEL
 VALVOLA MONO DIREZIONALE
 MONO-DIRECTIONAL VALVE

HARDNESS TOOL



16



-FIRE SAFE ISO FT+ "O" RING STELO
 -FIRE SAFE ISO FT+ "O" RING ON STEM
 -SECURITE FEU ISO FT+ TIGE AVEC "O" RING
 -FEUERSICHERE AUSFÜHRUNG ISO FT +
 "O" RING IM SPINDELBEREICH

FIRE SAFE ISO FT CERTIFICATE



THREAD GAUGES



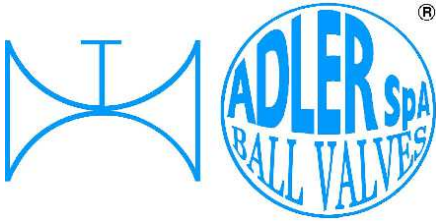

ISO 9001 by L.R.
 PED DIR. 2014/68/UE by L.R.
 ATEX DIR. 2014/34/UE by B.V.
 FIRE SAFE EXECUTION by L.R.
 ISO 15848 by TÜV
 ANTISTATIC DEVICE by L.R.
 FIRE SAFE TESTED ISO 10497 by L.R.
 EAC CERTIFICATION by B.V.

TYPE
FC1
 PN 63 ÷ 100 ÷ 160
 ANSI 600 ÷ 900 ÷ 1500

VITI D'ASSEMBLAGGIO PER FC1 - ASSEMBLING SCREWS FOR FC1 - VIS D'ASSEMBLAGE POUR FC1- MONTAGESCHRAUBEN FÜR FC1
 N° VITI - DIMENSIONE • N° SCREW - DIMENSIONS • N° VIS- DIMENSIONS • N° SCHRAUBEN-ABMESSUNGEN

EUROPEAN NORM

DN PN	10-15	20	25	32	40	50	65	80	100	125	150	200
63	8 M12 X35	8 M16 X40	8 M16 X45	8 M20 X50	8 M20 X50							
100	8 M12 X35	8 M16 X40	8 M16 X45	8 M20 X50	8 M20 X50							
160	8 M12 X35	8 M16 X40	8 M16 X45	8 M20 X50	8 M20 X55							

ANSI METRIC

(STANDARD ADLER)

Ø Rating	1/2"	3/4"	1"	1 1/4"	1 1/2"	2"	2 1/2"	3"	4"	5"	6"	8"
600	8 M14 X45	8 M16 X45	8 M16 X50	8 M16 X50	8 M20 X55							

ANSI B1.1 UNC

(ON REQUEST)

Ø Rating	1/2"	3/4"	1"	1 1/4"	1 1/2"	2"	2 1/2"	3"	4"	5"	6"	8"
600	8 1/2 x 1 3/4	8 5/8 x 1 3/4	8 5/8 x 2	8 5/8 x 2	8 3/4 x 2 1/4							

Length of screws calculated considering a gasket with thickness of 2mm.

