



ISO 9001 by L.R.
PED DIR. 2014/68/UE by L.R.
ATEX DIR. 2014/34/UE by B.V.
FIRE SAFE EXECUTION by L.R.
ISO 15848 by TÜV
ANTISTATIC DEVICE by L.R.
FIRE SAFE TESTED ISO 10497 by L.R.
EAC CERTIFICATION by B.V.

TYPE
FZ4
PN 10 ÷ 40
ANSI 150

NORME E DIRETTIVE APPLICATE DISPONIBILI AL SEGUENTE LINK:
STANDARD AND DIRECTIVE APPLIED AVAILABLE AT FOLLOWING LINK:
http://www.adlerspa.com/pdf/NORME_ADLER.pdf

VALVOLE A SFERA "3 VIE CORPO PIATTO" PASSAGGIO TOTALE 90° CON CAMICIA DI RISCALDAMENTO

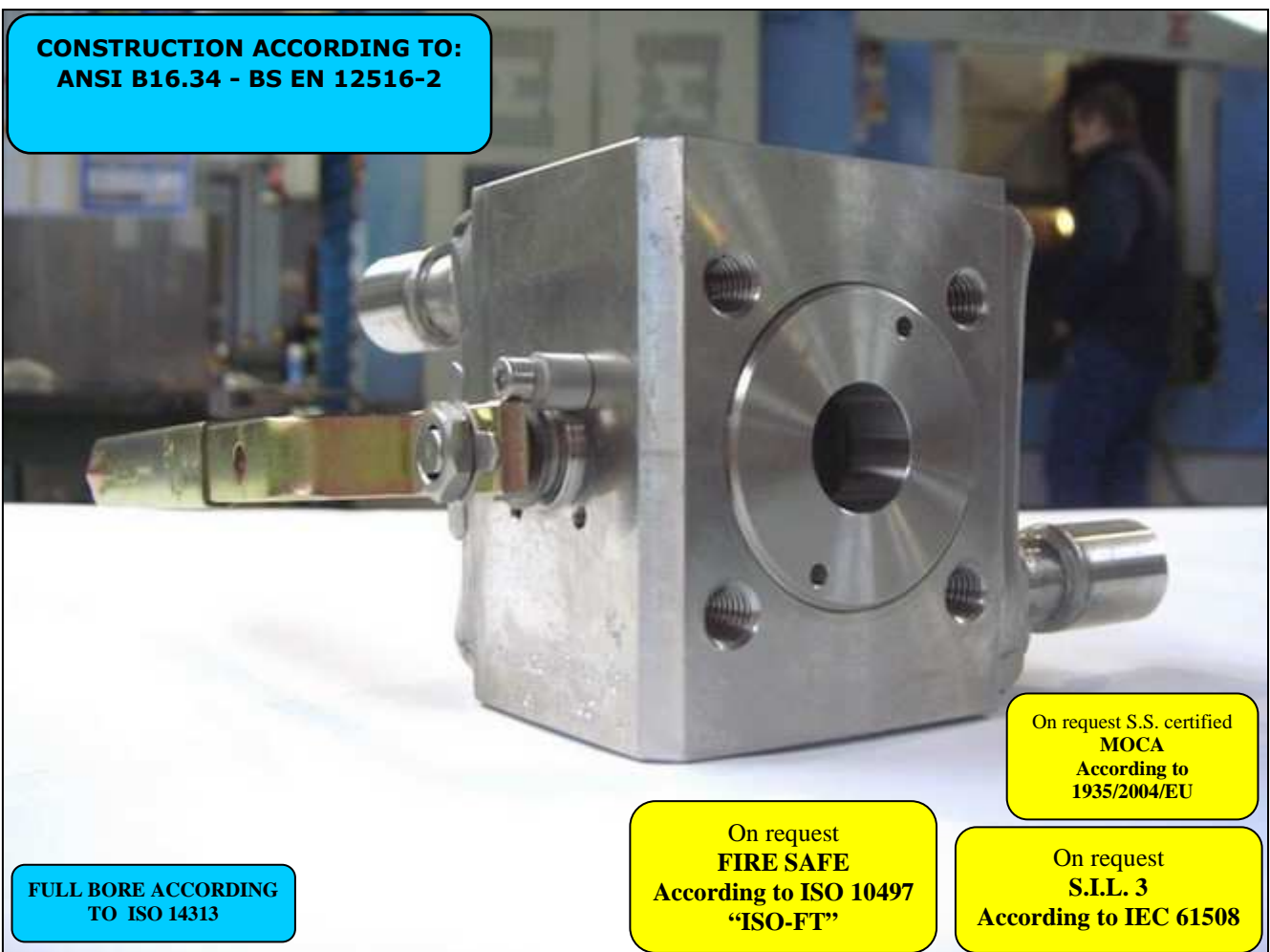

**BALL VALVES "3 WAY WAFER"
FULL BORE 90° WITH HEATING JACKET
ROBINETS A BOISSEAU SPHERIQUE
"3 VOIES WAFER"
PASSAGE INTEGRAL 90° AVEC ENVELOPPE
KUGELHÄHNE "3 WEGE KOMPAKTHAHN"
VOLLER DURCHGANG 90° MIT HEIZMANTEL**

WEB SITE: WWW.ADLERSPA.COM

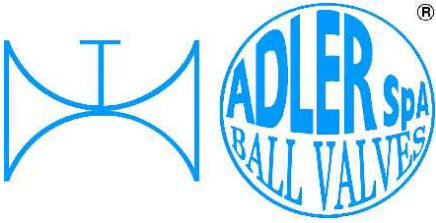

ISO 9001 by L.R.
 PED DIR. 2014/68/UE by L.R.
 ATEX DIR. 2014/34/UE by B.V.
 FIRE SAFE EXECUTION by L.R.
 ISO 15848 by TÜV
 ANTISTATIC DEVICE by L.R.
 FIRE SAFE TESTED ISO 10497 by L.R.
 EAC CERTIFICATION by B.V.

TYPE
FZ4
 PN 10 ÷ 40
 ANSI 150

VALVOLA A SFERA "3 VIE CORPO PIATTO" PASSAGGIO TOTALE 90° CON CAMICIA DI RISCALDAMENTO
 BALL VALVES "3 WAY WAFER" FULL BORE 90° WITH HEATING JACKET
 ROBINETS A BOISSEAU SPHERIQUE "3 VOIES WAFER" PASSAGE INTEGRAL 90° AVEC ENVELOPPE
 KUGELHÄHNE "3 WEGE KOMPAKTHAHN" VOLLER DURCHGANG 90° MIT HEIZMANTEL

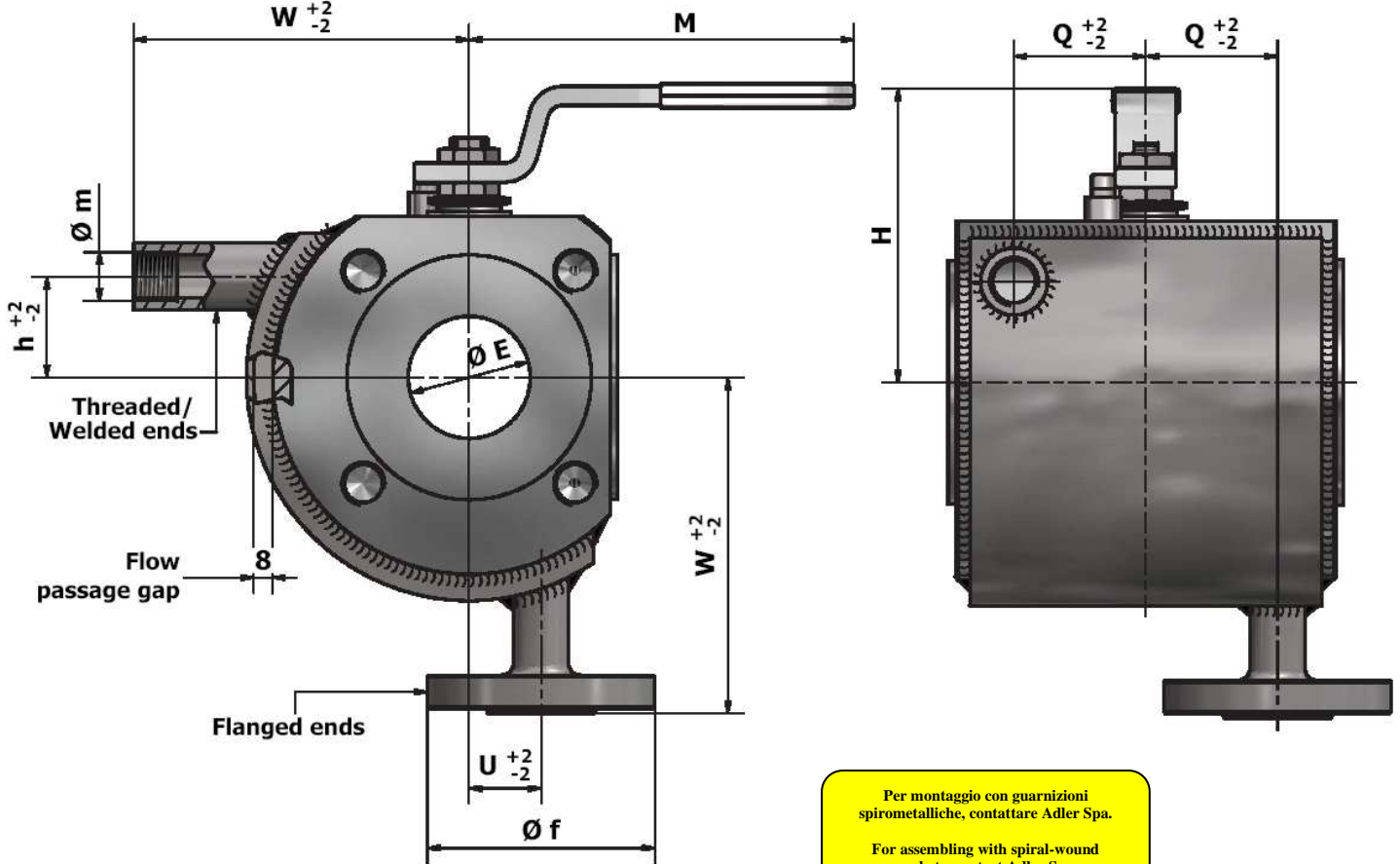

Per montaggio con guarnizioni
 spirometalliche, contattare Adler Spa.
 For assembling with spiral-wound
 gaskets, contact Adler Spa

Valvola base FZ4
 Main Ball Valve FZ4

Pressione massima di lavoro nelle camicie 10 bar
 Maximum working pressure for jacket 10 bar

Materiale camicia Jacket material	CARBON STEEL (STANDARD) STAINLESS STEEL (OPTIONAL)
--------------------------------------	---

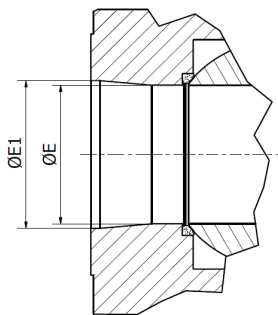

DN 100 ÷ 150

**VISUALIZZA 3D
 VIEW 3D**

<https://adlerspa.com/prodotti/fz4-2>

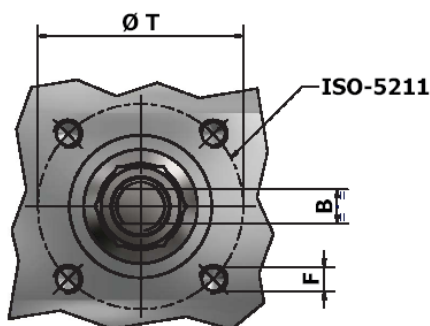

DN 65 PN 16 ESECUZIONE
 STANDARD CON 4 FORI
 SU RICHIESTA DISPONIBILE
 CON 8 FORI
 DN 65 PN 16 STANDARD
 EXECUTION WITH 4 HOLES
 ON REQUEST AVAILABLE WITH
 8 HOLES

POSIZIONI OTTENIBILI
 OBTAINABLE POSITIONS
 POSITIONS OBTENABLES
 MÖGLICHE STELLUNGEN

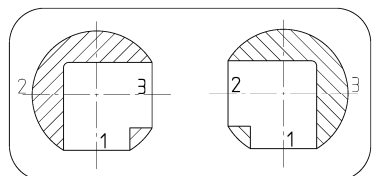

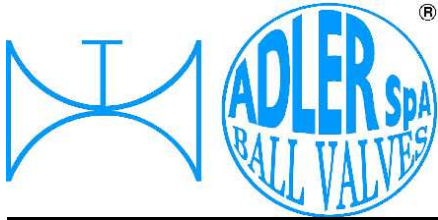

ISO 9001 by L.R.
 PED DIR. 2014/68/UE by L.R.
 ATEX DIR. 2014/34/UE by B.V.
 FIRE SAFE EXECUTION by L.R.
 ISO 15848 by TÜV
 ANTISTATIC DEVICE by L.R.
 FIRE SAFE TESTED ISO 10497 by L.R.
 EAC CERTIFICATION by B.V.

TYPE
FZ4
 PN 10 ÷ 40
 ANSI 150

N.	DESCRIZIONE DESCRIPTION BESCHREIBUNG	MATERIALI MATERIALS MATERIAUX WERKSTOFFE
1	CORPO BODY CORPS MITTE	ASTM A105 ASTM A479 304/304L ASTM A479 316/316L
2	GHIERA INSERT EMBOUT GEWINDED RUCKRING	ASTM A105 ASTM A479 304/304L ASTM A479 316/316L
3*	O-RING	FKM - (VITON)
4*	ANELLO SEAL ANNEAU DICHTUNGSRING	P.T.F.E.
5*	SEDE SEAT SIEGE SITZRING	P.T.F.E. R.P.T.F.E. (OPTIONAL)
6	SFERA BALL BOULE KUGEL	ASTM A479 304/304L ASTM A351 CF8 ASTM A479 316/316L ASTM A351 CF8M
7	DISPOSITIVO ANTISTATICO ANTISTATIC DEVICE CONTACT ANTISTATIQUE ANTISTATIK VORRICHTUNG	ASTM A479 316/316L
8	STELO STEM TIGE SPINDEL	ASTM A479 304/304L ASTM A479 316/316L

N.	DESCRIZIONE DESCRIPTION BESCHREIBUNG	MATERIALI MATERIALS MATERIAUX WERKSTOFFE
9*	BUSSOLA STEM SEAL JOINT TIGE UNTERE SPINDEL ABDICHTUNG	P.T.F.E.
10*	PACCO A "V" CHEVRON RINGS JOINT A "V" 3 FACHE DACHMANSCHETTE	P.T.F.E. / GRAFITE P.T.F.E. / GRAPHITE P.T.F.E. / GRAPHITE P.T.F.E. / GRAPHIT
11	PREMIBUSSOLA PRESSING BUSH PRESSE RONDELLE STOPFBUCHSDRUCKRING	ASTM A479 304
12	MOLLE A TAZZA SPRING WASHERS RONDELLES BELLEVILLE TELLERFEDERN	C72/50Cr V4 ZINCATO - GALVANIZED - ZINGUE - VERZINKT X10CrNi18.8 ON REQUEST
13	VITE DI FERMO E FERMO PIN AND STOP PIN PLOINT ET PLOT D'ARRET ANSCHLAGBOLZEN	UNI3740 8.8 ZINCATO - GALVANIZED - ZINGUE - VERZINKT UNI 3951 A2-70 ON REQUEST
14	DADO - CONTRODADO NUT - LOCK NUT ECROU - CONTRE-ECROU MUTTER - KONTERMUTTER	UNI 3740 - 6S ZINCATO - GALVANIZED ZINGUE - VERZINKT ASTM A479 304 ON REQUEST
15	LEVA WRENCH LEVIER HANDHEBEL	AISI 1010 CHROMED FOR S.S. VALVES ASTM A479 304 PAINTED FOR C.S. VALVES ON REQUEST
16		

* RICAMBI CONSIGLIATI - RECOMMENDED SPARE PARTS - PIECES DE RECHANGE CONSEILLEES - ERSATZTEIL EMPFEHLUNG

◇ ONLY IN VALVES DN20, 25, 32, 40, 80, 100, 125, 150

ON REQUEST P.T.F.E. AVAILABLE CERTIFIED BAM, FDA, MOCA

DIMENSIONI - DIMENSION - DIMENSIONS - ABMESSUNGEN

DN	10	15	20	25	32	40	50	65	65	80	100	100	125
A		10	10	12	12	16	16	22	22	22	30	30	30
B		6	6	8	8	10	10	14	14	14	18	18	18
C		7	7	10	10	15	15	17	17	17	17	17	17
ØE		15	19	25	30	38	51	64	64	76	98	98	115
ØE1		-	-	-	-	-	-	-	-	-	101	101	118
F		M5	M5	M5	M5	M6	M6	M8	M8	M8	M10	M10	M10
f		DN 15 PN 16						DN 25 PN 16					
ISO		F03	F03	F03	F03	F05	F05	F07	F07	F07	F10	F10	F10
G		25	25	25	25	35	35	55	55	55	70	70	70
H		70	75	90	95	112	122	147	147	149	174	174	183
h		19	23	25	28	33	42	57	57	58	68	68	70
M		145	145	185	185	280	280	370	370	370	470	470	650
m		Ø1/2" GAS						Ø1" GAS					
P		36,6	41	46	51	57	67	85	85	87	99,5	107	113
Q		32	34	36	47	50	55	62	62	78	80	80	100
R		8	8	17	17	20	20	23	23	23	26	18	26
W		32	40	41,5	52,5	56,5	62	70	81	87	96	106	116
S1		97	108	115	140	150	165	185	206	216	230	262	290
T		36	36	36	36	50	50	70	70	70	102	102	102
U		5	10	10	15	20	30	35	35	40	60	60	65
~Kg		5	7,5	8,5	13,5	17	19,5	27	36,5	56	71	92	127

- DATI E CARATTERISTICHE SOGGETTI A VARIAZIONI SENZA PREAVVISO
- SPECIFICATIONS SUBJECT TO MODIFICATIONS WITHOUT PRIOR NOTICE
- TOUS DROITS DE MODIFICATION RESERVES
- KONSTRUKTIONSÄNDERUNGEN VORBEHALTEN
- **ANSI 300 ON REQUEST**

PN 10 ÷ 16 - ANSI 150

PN 25 ÷ 40

PN 10 ÷ 40

DN 100 ANSI 150 S=100,5 S1= 240



ADLER SpA - BALL VALVES
 20010 S. STEFANO TICINO (MI) ITALY V.le BORLETTI, 14 Tel. +39/02974842.11 FAX +39/0297271698
 E-mail: adler@adlerspa.com <http://www.adlerspa.com>

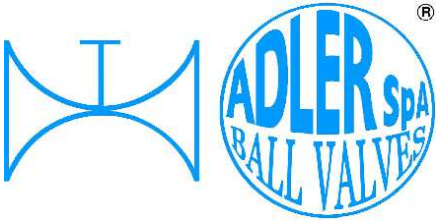

ISO 9001 by L.R.
 PED DIR. 2014/68/UE by L.R.
 ATEX DIR. 2014/34/UE by B.V.
 FIRE SAFE EXECUTION by L.R.
 ISO 15848 by TÜV
 ANTISTATIC DEVICE by L.R.
 FIRE SAFE TESTED ISO 10497 by L.R.
 EAC CERTIFICATION by B.V.

TYPE
FZ4
 PN 10 ÷ 40
 ANSI 150

• ESECUZIONI • EXECUTIONS • EXECUTIONS • AUSFÜHRUNGEN



EXECUTION 4- 12



EXECUTION 6 - 16

S STANDARD

O OPTIONAL

1 **S**

-MONTAGGIO VITI – SCREW ASSEMBLING
 -MONTAGE VIS – EINBAU MIT SCHRAUBEN

2 **S**

INDICATORE DI FLUSSO
 FLOW INDICATOR

3 **S**

VALVOLE CERTIFICATE S.I.L. 3
 VALVES CERTIFIED S.I.L. 3

4 **S**

-STELO ANTI ESPULSIONE –ANTI BLOW OUT STEM
 -TIGE ANTIEXPULSION –AUSBLASGESICHERTE WELLE

-PACCO A "V" –CHEVRON RINGS
 -JOINT A "V" –3 FACHE DACHMANSCHETE
 ANTISTATIC DEVICE ANTISTATIK VORRICHTUNG
 BS 5146

5 **S**

KEY TORQUE

6 **O**

BREVETTO – PATENTED
 00219688 - 21-04-1993
 FKM (VITON)

-“O” RING STELO “O” RING ON STEM
 -TIGE AVEC “O” RING
 -“O” RING IM SPINDELBEREICH



ISO 9001 by L.R.
 PED DIR. 2014/68/UE by L.R.
 ATEX DIR. 2014/34/UE by B.V.
 FIRE SAFE EXECUTION by L.R.
 ISO 15848 by TÜV
 ANTISTATIC DEVICE by L.R.
 FIRE SAFE TESTED ISO 10497 by L.R.
 EAC CERTIFICATION by B.V.

TYPE
FZ4
 PN 10 ÷ 40
 ANSI 150

7

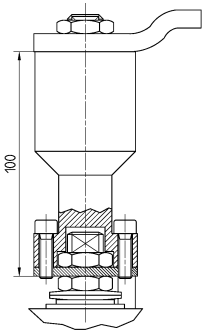

-PROLUNGA STELO -STEM EXTENSION
 -TIGE PROLONGEE -SPINDELVERLÄNGERUNG

8

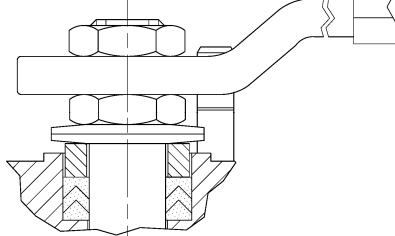

-PARTICOLARI INOX
 -STAINLESS STEEL DETAILS
 -ACCESSOIRES EN INOX
 -EDELSTAHLTEILE

9

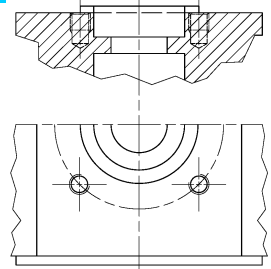

-ATTACCO "ISO" -"ISO" CONNECTIONS
 -SYSTEM "ISO" -ANSCHLUSS "ISO"

10

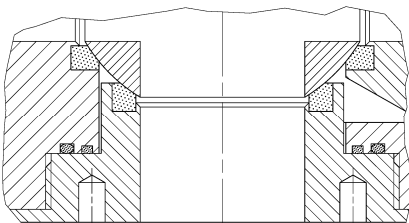

-SFERA CONTENUTA -CONTENTS BALL
 -BOULE CONTENUE
 -NICHT RAUSRAGENDE KUGEL

11

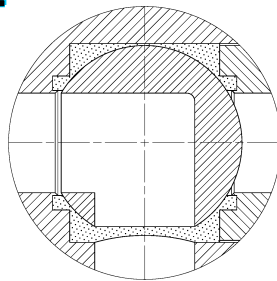

-TENUTE INTEGRALE -POCKETLESS SEATS
 -TENUE INTEGRALE -TOTRAUMARM
 -P.T.F.E. / R.T.F.E.

12

FIRE SAFE
 ISO 10497 "ISO-FT"
 (BS 6755 / API 607)



13

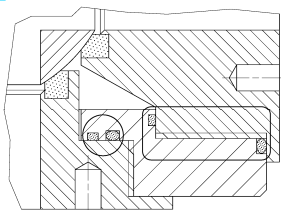

-DOPPIA TENUTA -DOUBLE SEALS
 -DOUBLE ETANCHEITE -DOPPELTE ABDICHTUNG
 -GHIERA A BATTUTA -METAL BEATING RING
 -EMBOUT AVEC BATTUE MECANIQUE
 -METALLISCHER ANSCHLAG DES
 GEWINDEDRUCKRINGS

ADLER COMPANY



15

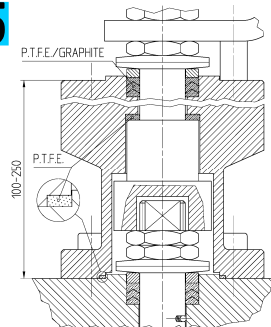

-SERVIZIO CRIOGENICO -CRYOGENIC SERVICE
 -SERVICE CRYOGENIQUE
 -TIEFTEMPERATUR SERVICE

16



-FIRE SAFE ISO FT+ "O" RING STELO
 -FIRE SAFE ISO FT+ "O" RING ON STEM
 -SECURITE FEU ISO FT+ TIGE AVEC "O" RING
 -FEUERSICHERE AUSFÜHRUNG ISO FT+
 "O" RING IM SPINDELBEREICH

17

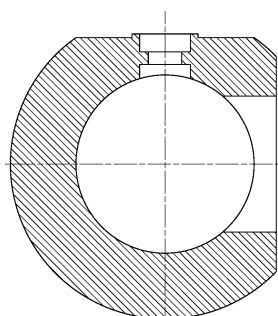

ADLER

UNA GAMMA COMPLETA
 PRIVILEGIANDO LA QUALITA'
 A COMPLETE RANGE PRIVILEGING
 THE QUALITY

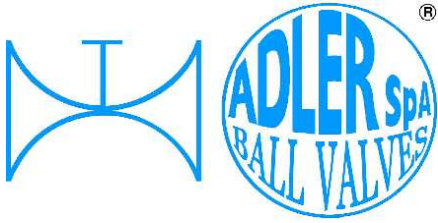

ISO 9001 by L.R.
 PED DIR. 2014/68/UE by L.R.
 ATEX DIR. 2014/34/UE by B.V.
 FIRE SAFE EXECUTION by L.R.
 ISO 15848 by TÜV
 ANTISTATIC DEVICE by L.R.
 FIRE SAFE TESTED ISO 10497 by L.R.
 EAC CERTIFICATION by B.V.

TYPE
FZ4
 PN 10 ÷ 40
 ANSI 150

VITI D'ASSEMBLAGGIO PER FZ4 - ASSEMBLING SCREWS FOR FZ4 - VIS D'ASSEMBLAGE POUR FZ4- MONTAGESCHRAUBEN FÜR FZ4
 N° VITI - DIMENSIONE • N° SCREW - DIMENSIONS • N° VIS- DIMENSIONS • N° SCHRAUBEN - ABMESSUNGEN

EUROPEAN NORM

DN PN	15		20		25		32		40		50		65		80		100		125		150		200	
16	12	M12 X30	12	M12 X30	12	M12 X30	12	M16 X35	12	M16 X35	12	M16 X40	12	M16 X40	24	M16 X40	24	M16 X40	24	M16 X45	24	M20 X45		
25	12	M12 X30	12	M12 X35	12	M12 X35	12	M16 X40	12	M16 X40	12	M16 X40	24	M16 X45	24	M16 X45	24	M20 X50	24	M24 X55	24	M24 X55		
40	12	M12 X30	12	M12 X35	12	M12 X35	12	M16 X40	12	M16 X40	12	M16 X40	24	M16 X45	24	M16 X45	24	M20 X50	24	M24 X55	24	M24 X55		

* N° 8 per UNI 2223/2229

ANSI METRIC

(STANDARD ADLER)

Ø Rating	1/2"		3/4"		1"		1 1/4"		1 1/2"		2"		2 1/2"		3"		4"		5"		6"		8"	
150	12	M14 X30	12	M14 X30	12	M14 X30	12	M14 X35	12	M14 X35	12	M16 X40	12	M16 X40	12	M16 X45	24	M16 X45	24	M20 X50	24	M20 X50		

ANSI B1.1 UNC

(ON REQUEST)

Ø Rating	1/2"		3/4"		1"		1 1/4"		1 1/2"		2"		2 1/2"		3"		4"		5"		6"		8"	
150	12	1/2 X 1 1/4	12	1/2 X 1 1/4	12	1/2 X 1 1/2	12	1/2 X 1 1/4	12	1/2 X 1 1/2	12	5/8 X 1 1/2	12	5/8 X 1 3/4	12	5/8 X 1 3/4	24	5/8 X 1 3/4	24	3/4 X 2	24	3/4 X 2		

Length of screws calculated considering a gasket with thickness of 2,5 mm.

